



**EN**

**Operating  
Instructions  
Sensor for  
Ambient-Conditions  
IAC 500**

### I. Foreword



Read these operating instructions carefully and completely before installation, commissioning and maintenance work. Follow the instructions to ensure safe operation and proper functioning.

The operating instructions must always be available at the place of use. It is not permitted to make only individual pages available.

#### **Imprint**

© CS Instruments GmbH & Co.KG | 24955 Harrislee | Gewerbehof 14 |  
GERMANY. Translation of the original German instructions. IAC 500 | DE | V1.00.

## II. Table of contents

<b>I ... Foreword</b> .....	<b>2</b>
<b>II ... Table of contents</b> .....	<b>3</b>
<b>1 ... Scope of delivery</b> .....	<b>5</b>
<b>2 ... Device overview</b> .....	<b>5</b>
<b>3 ... Type plates</b> .....	<b>6</b>
<b>4 ... Intended use</b> .....	<b>7</b>
<b>5 ... Use contrary to the intended purpose</b> .....	<b>7</b>
<b>6 ... Safety provisions</b> .....	<b>7</b>
6.1 Warning and information symbols used in these instructions .....	7
6.2 Warnings .....	8
6.3 General safety instructions .....	8
6.4 Spare parts/accessories .....	11
6.5 Environmental protection .....	11
<b>7 ... Product information</b> .....	<b>11</b>
7.1 Product features .....	11
7.2 Function .....	11
<b>8 ... Technical data</b> .....	<b>12</b>
8.1 Technical data and ambient conditions .....	12
8.2 Dimensions IAC 500 .....	13
<b>9 ... Wall assembly IAC 500</b> .....	<b>13</b>
9.1 Rotate the operating unit by 180° .....	14
<b>10. Electrical connection</b> .....	<b>15</b>
10.1 Service interface (Modbus-RTU, analogue output 4...20 mA) .....	15
10.2 Ethernet / Ethernet PoE (Power over Ethernet) .....	17
<b>11. Commissioning</b> .....	<b>18</b>
11.1 Switch on sensor .....	18
11.2 Main menu after switching on .....	18

<b>12. Operation</b> .....	<b>19</b>
<b>13. Settings menu</b> .....	<b>19</b>
13.1 Call up the settings menu .....	20
<b>14. Sensor setup</b> .....	<b>21</b>
14.1 Units.....	21
14.2 Pressure offset setting.....	22
14.3 Temperature offset setting.....	23
14.4 Rel. humidity offset setting.....	24
<b>15. Settings advanced</b> .....	<b>25</b>
15.1 Service interface (Modbus-RTU) .....	25
15.2 Switch/alarm output.....	26
15.3 User.....	27
15.3.1 Settings menu password, 4-digit .....	27
15.3.2 Language.....	27
15.3.3 Display-Brightness / Display-Rotation .....	28
15.4 Analogue output setting 4...20 mA.....	29
15.4.1 Channel 1.....	29
15.4.2 State .....	29
15.4.3 Unit .....	29
15.4.4 Scaling 4 mA and 20 mA.....	30
15.4.5 Fault current.....	30
<b>16. Ethernet settings</b> .....	<b>31</b>
16.1 IP address .....	31
16.2 Modbus-TCP setup.....	31
<b>17. Info</b> .....	<b>32</b>
<b>18. Status and error messages</b> .....	<b>33</b>
18.1 Error messages .....	33
<b>19. Maintenance</b> .....	<b>34</b>
19.1 Replacing the sensor unit .....	34
19.2 Maintenance.....	34
19.3 Calibration .....	34
19.4 Spare parts and repair.....	34
<b>20. Disassembly</b> .....	<b>34</b>
<b>21. APPENDIX</b> .....	<b>35</b>
21.1 Modbus-RTU settings (2001...2005).....	35
21.2 Values Register IAC 500 .....	35
21.3 Values Register Actual, Min & Max IAC 500 .....	36
21.4 Index Units .....	37
<b>Declaration of conformity</b> .....	<b>38</b>

## 1 Scope of delivery

- Ambient condition sensor IAC 500
- Holder
- Calibration certificate
- These operating instructions

## 2 Device overview

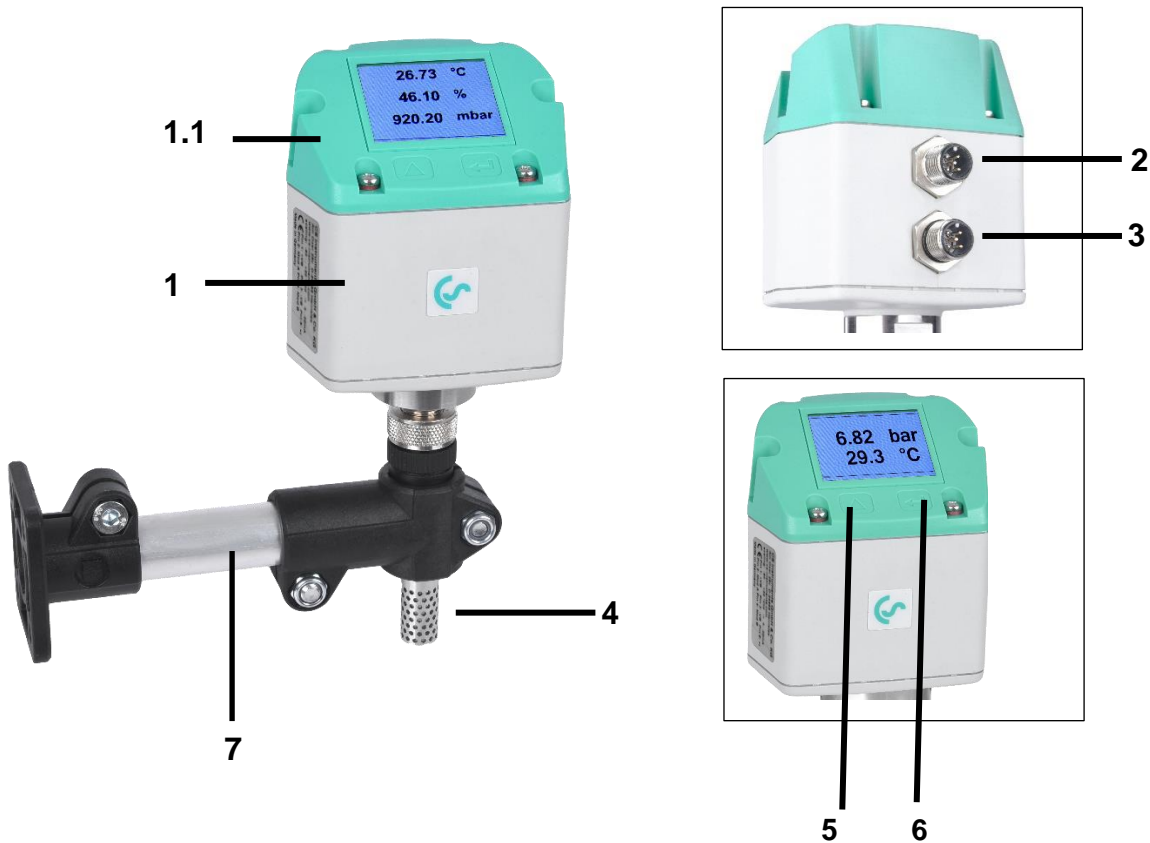

- 1 Control/operating unit
- 1.1 Cover with display (rotatable 180°)
- 2 Connector A (Power Supply, Modbus-RTU, 4...20 mA)
- 3 Connector B (Pulse, MBus, Ethernet)
- 4 Sensor unit
- 5 Selection button (UP)
- 6 ENTER/OK button
- 7 Holder

## 3 Type plates

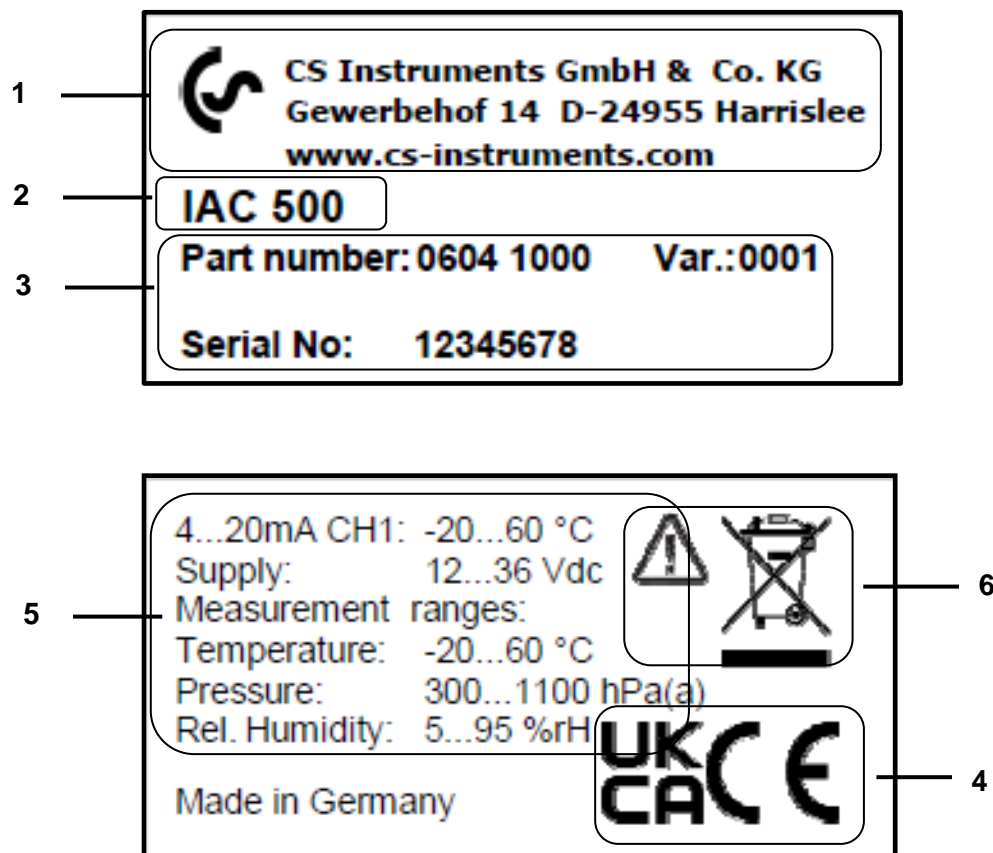

1

1 – Manufacturer info

2 – Sensor name

3 – Order numbers, serial number, production date

4 – Conformity/certification marking

5 – Electrical connection data:

e.g. available inputs and outputs, supply voltage

6 – Warning notice "Operating instructions must be observed".

“

## 4 Intended use

Ambient condition sensor IAC 500 is a measuring probe used to analyse the ambient air (such as the intake air for a compressor). In this case, the absolute pressure, the ambient temperature and the humidity in the room are determined.

**Operation of the IAC 500 is only permitted under the following circumstances:**

- Only use the sensor indoors  
The sensor must be protected from direct sunlight, rain, splash water and excessive dust.
- In ambient air with clean and oil-free properties.
- According to the technical data and approved ambient conditions.
- With correct calibration → chapter 22.3.

## 5 Use contrary to the intended purpose

**Misuse when used as a climbing aid!** The ambient condition sensor can be damaged. Danger of slipping. Select the installation location so that the ambient condition sensor cannot be used as a climbing aid. Never use the ambient condition sensor as a step or climbing aid.

**Non-permissible operating conditions cause incorrect measurement results to occur.**

Do not install the ambient condition sensor near heat sources (radiators, refrigerator and so on). Ensure sufficient air circulation. Keep a distance to the corner of the room of at least 0.5 m. Polluted air (oil, chemicals and so on) can damage the sensor unit and cause repairs by the manufacturer to be necessary.

## 6 Safety provisions

### 6.1 Warning and information symbols used in these instructions



In these operating instructions, this symbol is found next to all work safety instructions where there is danger to life and limb. Observance of these instructions and cautious behaviour are particularly important in these cases. All work safety instructions must also be shared with other users. In addition to the instructions in these operating instructions, the general safety and accident prevention regulations must be observed.



This symbol is located at points in the operating instructions where special attention must be paid to ensure that the guidelines, regulations, instructions and the correct procedure for the work are observed and that damage and destruction are prevented.



This symbol indicates important information or measures for the protection of the environment.



This symbol indicates particularly important information for operators.

### 6.2 Warnings

Warnings are subdivided according to the hazard levels **DANGER**, **WARNING** and **CAUTION**. Meaning of the warnings:



**DANGER**  
**Immediate danger!**

▶ Failure to observe this information may result in serious injury or death.



**WARNING**  
**Potentially dangerous situation!**

▶ Failure to observe this information may result in serious injury or death.



**CAUTION**  
**Potentially dangerous situation!**

▶ Failure to observe this information may result in moderate to minor injuries.



**NOTE**  
**Potentially dangerous situation!**

▶ Failure to observe this information may result in property damage.

### 6.3 General safety instructions

#### Important notes for installation and maintenance personnel

The ambient condition sensor may only be installed by trained specialists with knowledge and experience in compressed air and electrical engineering.

Electrical connection, commissioning and maintenance are only to be carried out by qualified electricians in accordance with the electrotechnical regulations (DIN EN 50110-1, DIN EN 60204-1 and so on). Prerequisite for the specialist personnel: Technical training and knowledge of technical standards, EU directives and EU regulations.

The applicable national accident prevention regulations and ordinances and general occupational health and safety measures must be observed, such as through wearing of suitable and prescribed personal protective equipment (PPE).

Only the manufacturer is permitted to perform repairs and adjustments. Installation and maintenance by trained specialist personnel.



### Obligations of the installer and system operator

The ambient condition sensor must be checked and maintained regularly by a trained and qualified individual → chapter 22.

Cleaning and maintenance intervals are to be determined by the system operator in accordance with DIN-ISO certification – frequency depending on ambient conditions and anticipated considerations.

**Calibration:** A (re)calibration is to be carried out depending on operational specifications and any intended DIN ISO certifications. Regular calibration is usually recommended after 2 years or at intervals determined by the operator. → chapter 22. Keep an identical replacement sensor ready for use in systems that are essential for operation.



#### NOTE

▶ Without the consultation and approval of CS Instruments GmbH & Co.KG, the warranty claim is void in case of conversion work which is not listed in these operating instructions. This symbol is located at points in the operating instructions where special attention must be paid to ensure that the guidelines, regulations, instructions and the correct procedure for the work are observed and that damage and destruction are prevented.

---

**Obligations of the installer of the system:** The installer of the system is responsible for the safety of the system in which the IAC 500 is installed. Pay particular attention to the technical data and ambient conditions (chapter 8) and the information on the electrical connection and prescribed connection cables (chapter 10).

---

Only use the IAC 500 as intended.

---

**Risk of injury and accidents when operating outside the permissible ambient/operating conditions or operating temperatures due to overpressure or faulty installation.** Comply with maximum permissible operating pressure. Ensure that the ambient condition sensor is only operated within the permissible limit values (→ type plate).

---

**Risk of injury due to unauthorised unit modifications, incorrect installation or damaged components.** The operating licence expires in these cases. **Operation is only permitted with original components.** Only operate the ambient condition sensor when it is completely assembled. Do not operate a damaged sensor, and prevent further use of the sensor until it is repaired. The sensor must be checked and maintained regularly by trained and qualified individuals. Device modifications are not permitted and release the manufacturer from any warranty and liability.

---

**Dirt particles in the ambient air can cause measurement errors.** Dirt particles and liquids can contaminate the sensor element and lead to malfunction or failure.

---

The system operator must ensure the prescribed purity of the air approved for the application as well as appropriate cleaning and maintenance intervals. The manufacturer provides no warranty and accepts no liability of any kind with regard to misuse.

---

**Explosion hazard in potentially Ex-protective zones due to ignition of explosives when sparks are generated.** The ambient condition sensor does not have Ex approval! Do not use the ambient condition sensor in Ex-protective zones.

---

**Ensure clean ambient air without harmful components.** Harmful components include explosive or chemically unstable gases and vapours, acid or base-forming substances such as ammonia, chlorine or hydrogen sulphide and condensates or oils and oil vapours.

---

**Password protection in the settings menu:** Password protection is provided to protect against unauthorised entries/settings of the system parameters. For setting the password → chapter 17.1.

---

**Danger if the applicable regulations for electrical installations are not observed.** For electrical installation, observe the applicable regulations, e.g. DIN EN 50110-1. In Germany observe in particular VDE 0100 in the relevant parts. Observe local regulations. Before working on the electrical installation, switch off all supply circuits, switch off the mains fuse and secure against being switched on again. Ensure voltage-free status. Operate the ambient condition sensor only with permissible connection cables for the mains supply and bus connection → technical data. Establish the electrical connection according to the wiring diagram (→ chapter 9).

---

**Exercise due care when handling packaging materials.** Comply with applicable safety and accident prevention regulations. Keep packaging material out of reach of children (choking hazard if foil or small parts are swallowed).

---

### 6.4 Spare parts/accessories

#### Spare parts

- Cover with display
- Sensor unit
- Holder



#### NOTE

▶ Only trained specialist personnel may replace the cover and display of the operating unit. To ensure measurement accuracy and operational safety, all other repairs may only be performed by the manufacturer. Please contact CS Instruments GmbH & Co.KG. They will be happy to help you.



#### NOTE

▶ Keep an identical replacement sensor ready for use in systems that are essential for operation.

### 6.5 Environmental protection

The ambient condition sensor and also the packaging contain recyclable materials that should not be disposed of in the residual waste. At the end of use, dispose of the packaging materials and ambient condition sensor in an environmentally friendly manner in accordance with the regulations in your country.

**Germany:** Disposal code according to the Waste Catalogue Ordinance (AVV) **16 02 14**, electrical and electronic devices and their components.

## 7 Product information

### 7.1 Product features

- Units can be selected as required: °C, °F, hPa, mbar, bar, psi, % RH.
- Two-button input on the display
- 1x analogue output 4...20 mA, adjustable for the atmospheric pressure, temperature and rel. humidity parameters  
**Optional:** 2x analogue output 4..20mA
- Modbus of RTU interface (RS-485)  
**Optional:** Ethernet/Ethernet PoE and M-Bus
- Switching/alarm output, galvanically isolated. Alarm adjustable via keypad.
- IP 65 housing

### 7.2 Function

The ambient condition sensor IAC 500 analyses the ambient air (intake air for a compressor) and determines the absolute pressure, ambient temperature and humidity in the room.

## 8 Technical data

### 8.1 Technical data and ambient conditions

Parameters	Absolute pressure, ambient temperature, humidity in the room
Temperature measuring range	-20...+60 °C/-4...140 °F
Accuracy of temperature	±1.0 K (0...60 °C), ±1.25 K (-20...0 °C) ±1.0 K (32...140 °F), ±1.25 K (-4...32 °F)
Rel. humidity measuring range	5...95% RH.
Rel. humidity accuracy	±3%
Absolute pressure of measuring range	300...1100 hPa (a)
Absolute pressure accuracy	±1.7 hPa at 20°C
Operating temperature	-20...+60 °C/-4...+140 °F
Ambient temperature	-20...+60 °C/-4...+140 °F
Storage temperature	-40...+80 °C/-40...+176 °F
Pollution level	Pollution level 2
Operating height, storage height	0...2000m (0...6560 ft)
Relative humidity (transport, storage, operation)	0% to 90% (non-condensing)
Power supply	18 to 36 VDC via SELV supply, 5 W or Power over Ethernet according to IEEE 802.3af, class 2 (3.84...6.49 W). Fuse protection in supply unit T2.5L 125V
Power consumption	Max. 6.5 W
Signal output	Modbus-RTU (RS-485) 1x AO 4...20 mA (pressure, temperature or rel. humidity) Optional: Modbus-TCP Ethernet / Ethernet PoE M-Bus 2 x analogue output 4..20mA
Power consumption	Max. 6.5 W
Measured values with Modbus-TCP	Pressure (hPa, mbar, bar, psi) Temperature (°C, °F) Rel. humidity (% RH)
Electrical connection	2x M12 flush-type connector, 5-pin (A-coded) Option Ethernet: 1 x M12 socket, 8-pin (X-coded)
Protection class	IP 65

## 8.2 Dimensions IAC 500

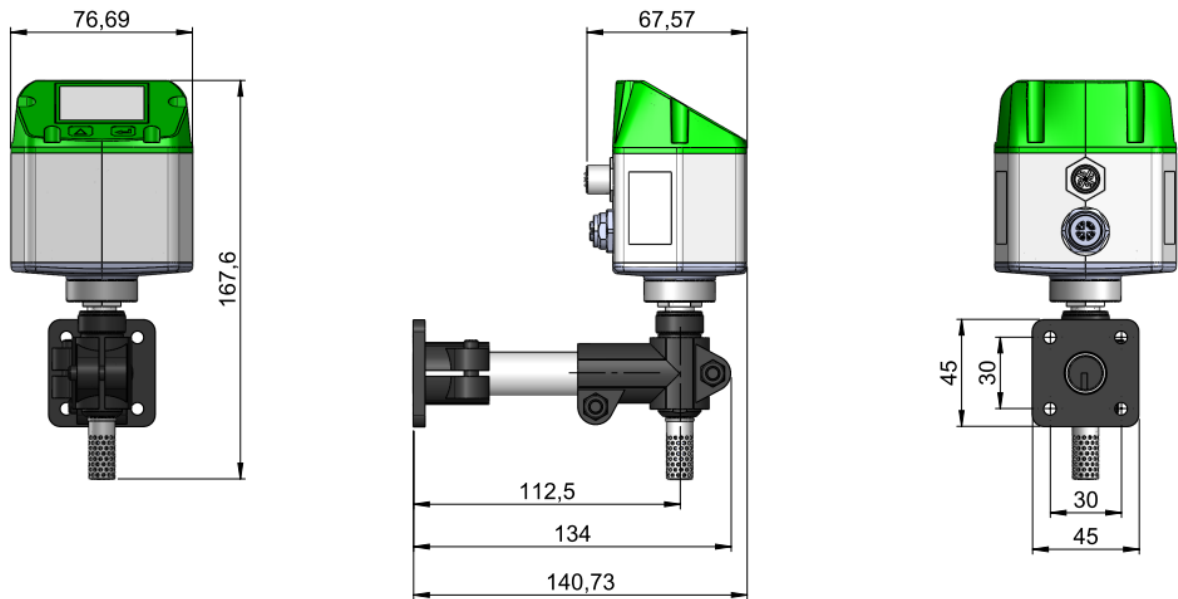

## 9 Wall assembly IAC 500

**NOTES**

- ▶ Permissible distance of the sensor centre of the ambient condition sensor to wall = at least 110 mm. Too small a distance can lead to faulty measurement results.
- ▶ Make sure that the sensor unit is exposed and not affected by environmental influences (heat sources). Ensure sufficient air circulation.
- ▶ Condensate and particles in the ambient air can contaminate the sensor element and lead to faulty measurement results.
- ▶ If necessary, rotate the display head of the operating unit 180° (→ chapter 9.1) or rotate the display (for reading direction, rotate the LCD upside down → chapter 17.3).

1. Mount the ambient condition sensor at a minimum distance of 110 mm from the wall. A holder can be installed by the customer. If desired, install the holder → figure.
2. A vibration-free, solid and load-bearing wall is required for mounting the sensor.

### 9.1 Rotate the operating unit by 180°

If desired, rotate the operating unit by 180°.



3. Loosen the six fastening screws [S] (Torx 10).
4. Pull up the operating unit and rotate it by 180°.



#### NOTE

▶ Malfunctions/damage to the unit may result if it is incorrectly installed. Check the position of the head gasket. Ensure that the connection cables can be correctly plugged into flush-type connectors [2] and [3].

5. Tighten the operating unit with the six fastening screws [S], tightening torque 5 Nm.

## 10 Electrical connection

Work on the electrical system may only be carried out by qualified electricians or other competent persons. For electrical installation, observe the applicable regulations, e.g. DIN EN 50110-1. In Germany observe in particular VDE 0100 in the relevant parts or other national regulations accordingly.

### 10.1 Service interface (Modbus-RTU, analogue output 4...20 mA)

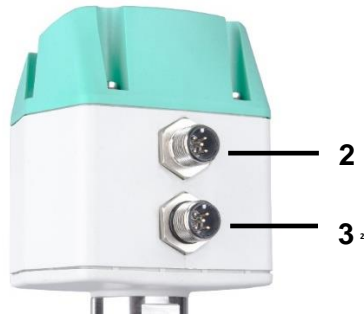

- 2 Connector A: Modbus-RTU, voltage/power supply, 4...20 mA output: M12 flush-type connector, 5-pin, A-coded
- 3 Connector B: Pulse output, M-Bus interface M12 flush-type connector, 5-pin, A-coded

**Pre-assembled connection cables available as accessories.**



**NOTE**

▶ Do **not** connect unneeded connections (NC) to potential and/or earth. Cut off unneeded cables and insulate them properly.

	Pin 1	Pin 2	Pin 3	Pin 4	Pin 5
Connector A	+VB	RS 485 (A) RS 485 (+)	-VB	RS 485 (B) RS 485 (-)	I+ (4..20 mA)
Connector B Pulse output (standard)	NC	GND	DIR	Pulse galv. isolated	Pulse galv. isolated
Connector B Option: 2x 4.20mA)	I+ 4..20 mA)	Pulse galv. isolated	Pulse galv. isolated	Pulse galv. isolated	Pulse galv. isolated
Connector B M-Bus	NC	Pulse galv. isolated	Pulse galv. isolated	MBus	MBus
Wire colour 0553.0106 (5 m) 0553.0107 (10 m)	Brown	White	Blue	Black	Grey

- VB Negative supply voltage 0 V
- +VB Positive supply voltage 18...36 VDC smoothed
- I + Current signal 4...20 mA – selected measuring signal
- Switching output relay output (normally closed), max. 48 V, 0.05 A
- RS-485 (A) Modbus-RTU A/Modbus-RTU (+)
- RS-485 (B) Modbus-RTU B/Modbus-RTU (-)

**M12 connector plug**

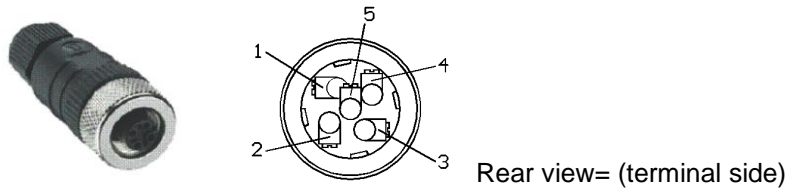

If no connection cable/pulse line has been ordered, the sensor is supplied with M12 flush-type connector, 5-pin, A-coded. The user can connect the signals as shown in the connection diagram.

**Connector plug A [2]: M12 flush-type connector, A-coded**

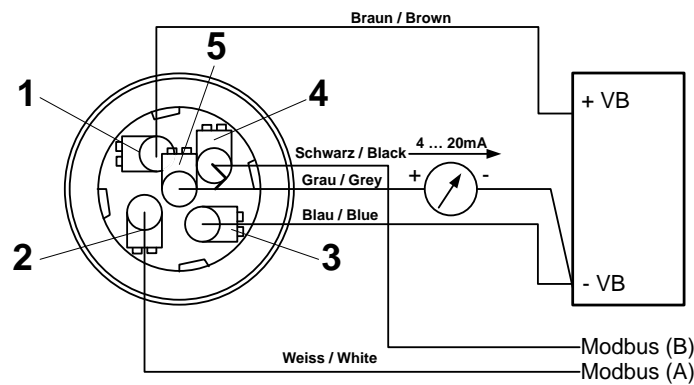

**NOTE**

▶ For Modbus-RTU setup → chapter 15 and tables in the appendix.

**Connector plug B [3]: M12 flush-type connector, A-coded**

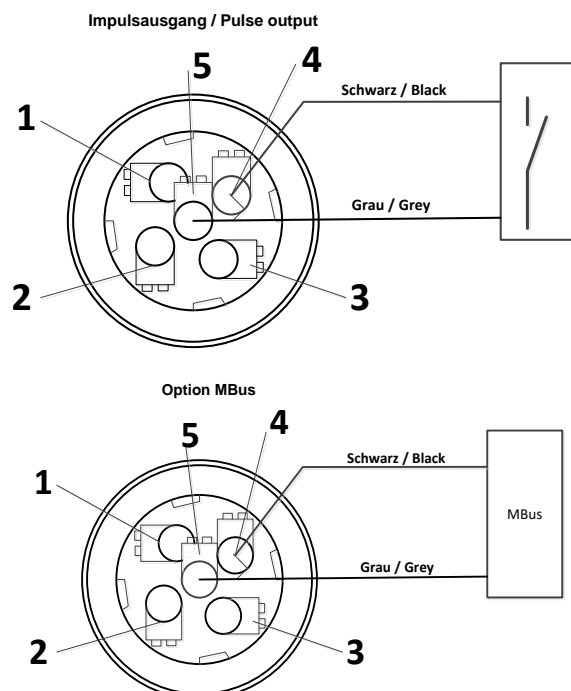



10.2 Ethernet / Ethernet PoE (Power over Ethernet)



- 3 Connector Ethernet / Ethernet PoE:  
M12 Ethernet flush-type connector, X-coded



**NOTE**

- ▶ Connector for Ethernet (PoE): M12 X-coded 8-pole (socket)
- ▶ Connection cable M12 D-coded (plug) to RJ45, data cables: 1,2 and 3,4 and PoE cables 5,6 & 7,8

Connector B [3]

M12 x-coded 8 pole

Connection cable

M12 x-coded to RJ45

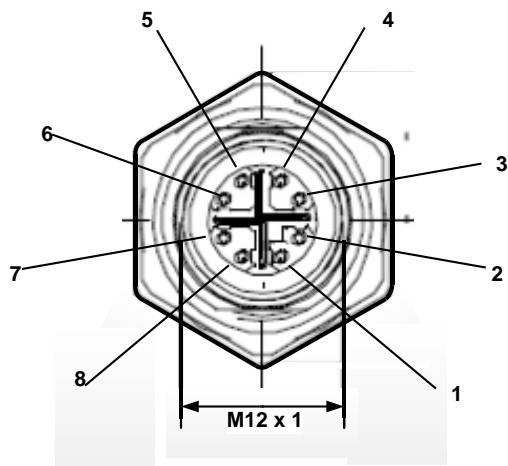

M12 jack

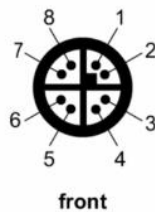

RJ45 plug

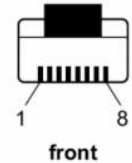
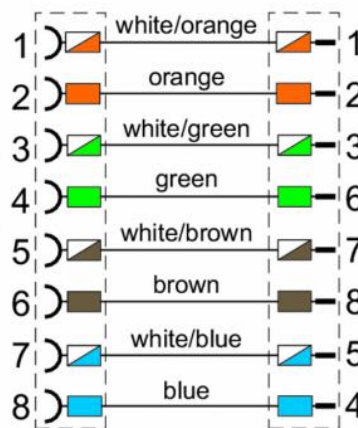

Shield connected

Connection cable: Cat 6.

**Remark:**

PTS 500 Power Classification acc. IEEE 802.3af: Class 2 (3,84W – 6,49W)

\*PoE: Power over Ethernet

## 11 Commissioning

### 11.1 Switch on sensor

1. Ensure that the IAC 500 is correctly connected.
2. After connecting the power supply (initial start or after a reset), the ambient condition sensor switches on and carries out a device initialisation for approx. 2...3 seconds.

### 11.2 Main menu after switching on

Start screen: Info page 1

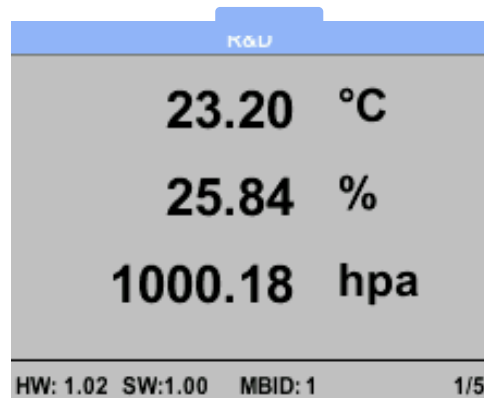

Press the  button to switch between the info pages.

Info page 2

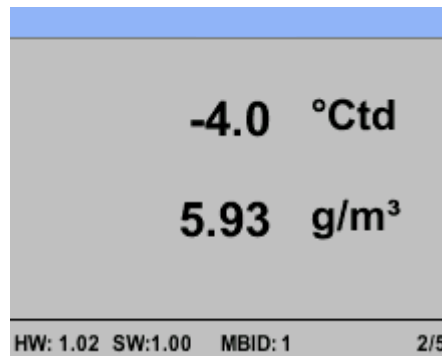

Info page3

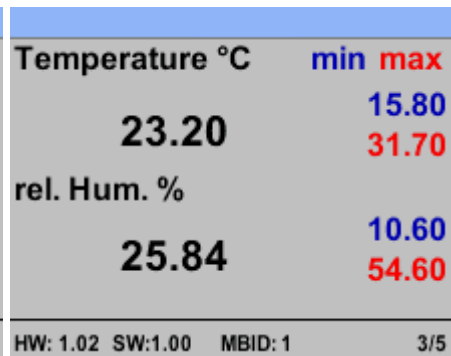

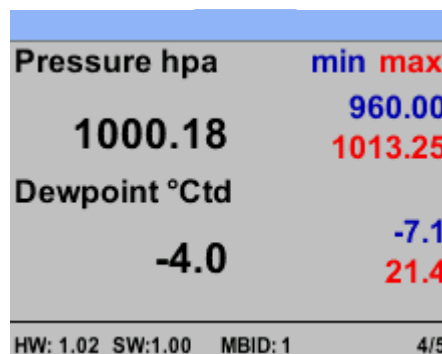

Info page 4

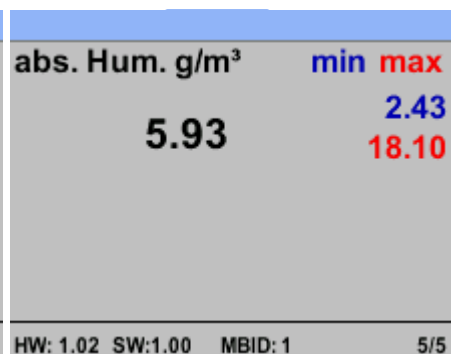

Info page 5



## 12 Operation

- You select a menu item, button field or input value with the  button.
- To reach the selected menu/button field or to confirm the input value, press the  button, depending on which menu/button field you are in.
- Pressing **Back** takes you to the menu above.

## 13 Settings menu

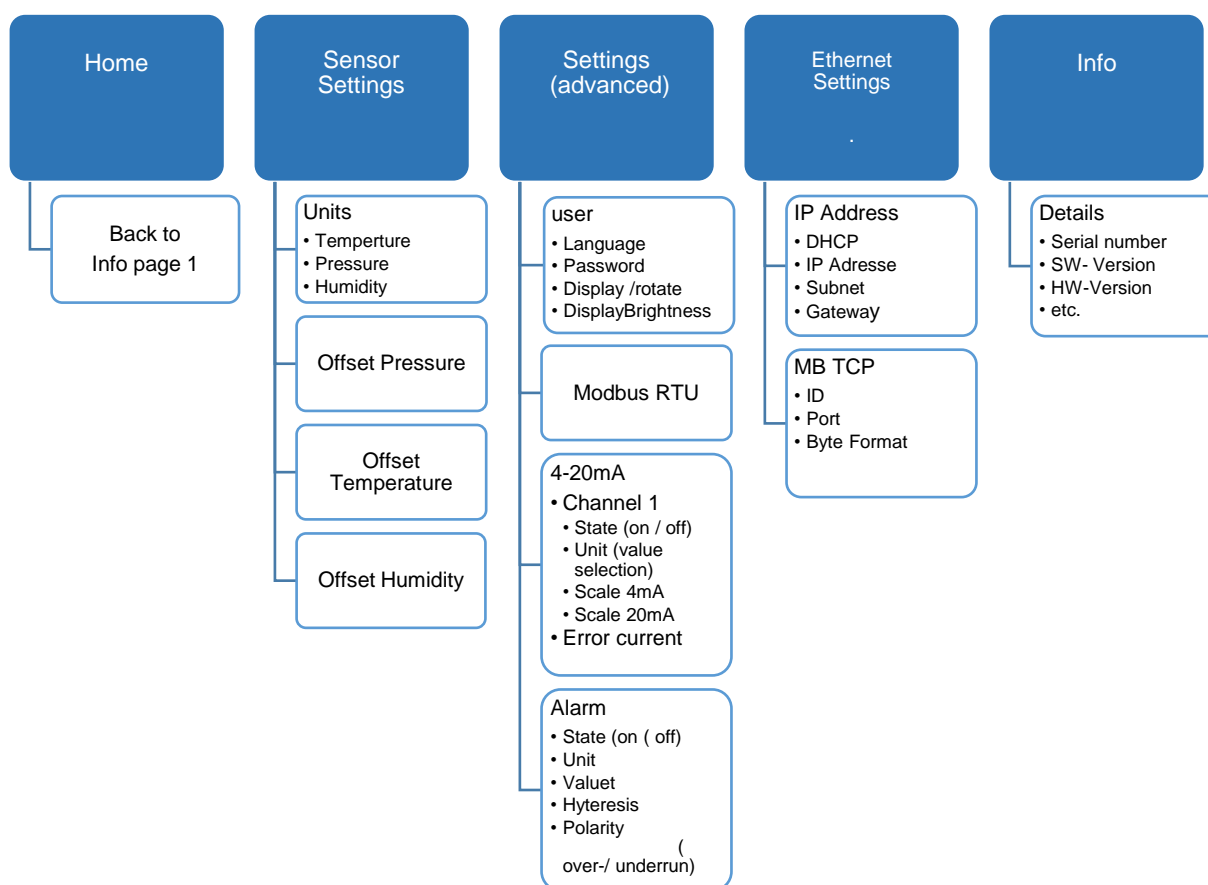



### 13.1 Call up the settings menu

**NOTE**

Password ex works = 0000. If the password has been changed and forgotten, access is granted with a master password. In such a case, please contact CS Instruments GmbH & Co.KG.

**NOTE**

To assign a new password, select **Settings** → **User** → **Password** → **Change**.

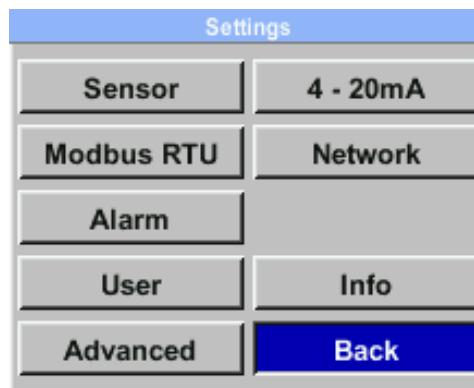

1. Press the  button. The password input field appears.
2. Enter the 4-digit password.
3. Confirm with .

The **Settings** menu appears

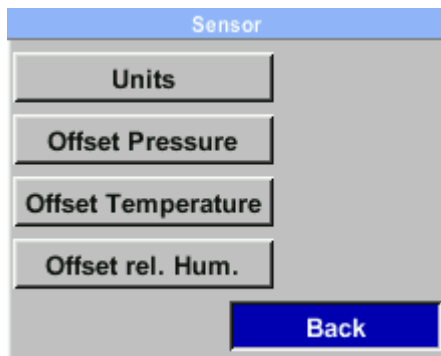

## 14 Sensor setup





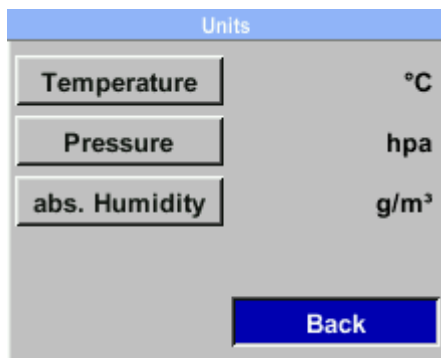

1. Select the **Sensor** menu in the Settings menu with  and confirm with .
- Selection fields:** Units, offset pressure, offset temperature and offset rel. humidity.
2. Press **Back** → main menu.

### 14.1 Units



Here you can define the units for the temperature (°C, °F), the pressure (hPa, mbar, bar, psi, Mpa) and the calculated abs. humidity in mg/m<sup>3</sup>, g/m<sup>3</sup>.

1. Use selection field  to select. Confirm with .
- The currently set unit appears in the display field.
2. Select another unit with . Confirm with  2x.
  3. Press **Back** → main menu.

## 14.2 Pressure offset setting

The screenshot shows a menu titled "Offset Pressure". It displays two rows of data: "Actual Value: 1000.18 hpa" and "Offset: 0.00 hpa". Below the data, there are three buttons: "set value to" (a grey button), "reset" (a grey button), and "Back" (a blue button).









**NOTE**

**Offset:** The offset value is used to compensate for minor deviations between the signal value and measuring range value that may occur after prolonged operation.

**Recommendation:** Perform recalibration from time to time to ensure high accuracy.

**NOTE**

The offset value can be determined with a reference check or with a second ambient condition sensor.

1. To change the offset pressure, select the corresponding input field with  and confirm with .
2. Select **Set value to** with . Confirm with  2x.
3. To enter a numeric field, select with  and confirm with .
4. Increase the number value with . Confirm the entry with .
5. **CLR** resets the display to 0.
6. Press **OK** → accept the new value.
7. Press **Back** → save and return to the main menu.

### 14.3 Temperature offset setting

Offset Temperature	
Actual Value:	23.20 °C
Offset:	0.00 °C
set value to	reset
Back	



#### NOTE

**Offset:** The offset value is used to compensate for minor deviations between the signal value and measuring range value that may occur after prolonged operation.

**Recommendation:** Perform recalibration from time to time to ensure high accuracy.



#### NOTE

The offset temperature can be determined with a second thermometer.

1. To set the **Temperature Offset**, select the **Set value to** input field with and confirm with .
2. To enter a numeric field, select with and confirm with .
3. Increase the number value with . Confirm the entry with .
4. Use **Calibration** to accept the reference value entered, such as a comparison value for a newly calibrated ambient condition sensor or service sensor.
5. Reset to the factory settings with **Reset**.
6. Press **Back** → save and return to the main menu.

## 14.4 Rel. humidity offset setting

Offset rel. Hum.		
Actual Value:	25.84	%
Offset:	0.00	%
set value to		reset
Back		

**NOTE**

**Offset:** The offset value is used to compensate for minor deviations between the signal value and measuring range value that may occur after prolonged operation.

**Recommendation:** Perform recalibration from time to time to ensure high accuracy.

**NOTE**

The offset temperature can be determined with a second thermometer.

1. To set the **Rel. humidity offset**, select the **Set value to** input field with and confirm with .
2. To enter a numeric field, select with and confirm with .
3. Increase the number value with . Confirm the entry with .
4. Use **Calibration** to accept the reference value entered, such as a comparison value for a newly calibrated ambient condition sensor or service sensor.
5. Reset to the factory settings with **Reset**.
6. Press **Back** → save and return to the main menu.



## 15 Settings advanced

### 15.1 Service interface (Modbus-RTU)

The ambient condition sensor is equipped with an RS-485 interface (Modbus-RTU), which is deactivated ex works. **Only connect the sensor to the Modbus after completing the following adjustment tasks:**

1. If the pressure sensor is installed at the end of the Modbus line, terminate it (if not → point 2.). To do this, set the internal **switch to ON**. Alternatively, a 120R resistor can be installed in the plug between pin 2 and pin 4 → chapter 10, Electrical connection. To open the operating unit, → chapter 9.2.

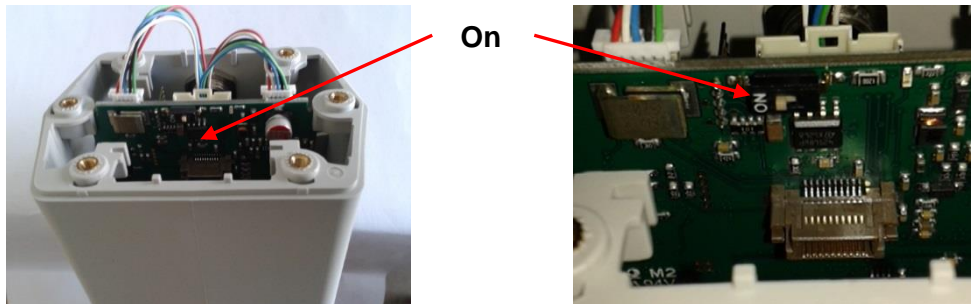







Check Modbus parameter values and adjust if necessary.

#### Settings → Modbus RTU

Interface parameters	Factory setting
• Modbus ID/sensor ID	1
• Baud rate	19200
• Stop bit	1
• Parity	even
• Byte format	ABCD

#### Set ID, baud rate, stop bit, parity and byte format

2. Use  to select the desired selection field and confirm with .
3. Use  to select the desired numeric field and confirm with .
4. Set the value with  and accept with .
5. Press **Save** to save the setting.
6. Press **Back** → main menu.



#### NOTE

**Byte format** allows you to set the data format (word order). To change available formats = ABCD (Big Endian) and CDAB (Middle Endian).



**Reset** to factory setting with **set default values**.

If the parameters between the master and slave are different, there is **no communication** between the units.

7. Only now connect the ambient condition sensor to the Modbus.

## 15.2 Switch/alarm output





After calling up the menu, the first field is activated (blue background).

1. Use  to activate/deactivate the **Alarm output** and confirm with .
2. Make further settings for the alarm:  
**Selection fields:** Unit, value, hyst., fall below/exceed
3. Press **OK** → main menu.



### Selection fields

- Units: °C, °F, hPa, mbar, bar, psi, % RH, °Ftd, °Ctd.
- Value defines the alarm value.
- Hyst. defines the desired hysteresis.
- Exceed/fall below determines when the alarm responds:  
exceed = exceeding value/fall below = falling below value



### Setting

1. Use  to select the desired selection field and confirm with .
2. **Button**  to move to the next data field or position or to change the setting value and confirm each with .
3. Press **Save** to accept the setting.

### 15.3 User

1. Select the **User** menu in the Settings menu with  and confirm with .

**Selection fields:** Password, Language, Rotate screen



2. Use  to select the desired selection field and confirm with .

#### 15.3.1 Settings menu password, 4-digit



**NOTE**

Password ex works = 0000. If you have forgotten the password, you can gain access with a master password. Contact CS Instruments GmbH & Co.KG if necessary.

1. Use  to select the **Password** selection field and confirm with .
2. Enter a new password. To do this, press one of the **numeric buttons** and confirm with . Set the other three digits in the same way.

Press the  button to delete the last digit.



3. Enter the **password a second time** and confirm with .

The new password is now valid.



4. Press **Back** → main menu.







#### 15.3.2 Language



Here you can select one of the four stored languages: German, English, Spanish, French & Turkish– default setting = German.

1. Use  to select the desired **language** and confirm with .
2. Press **Back** → main menu.

### 15.3.3 Display-Brightness / Display-Rotation

The brightness on the display can be adjusted in % steps with  and  → bar chart. To reduce energy consumption, dimming makes the screen dim after the time that has been set elapses.

1. Use  and  to adjust the screen brightness.
2. Use  to select the desired **time** (in min.) and confirm with .
3. If the control is mounted rotated by 180°, rotate the display 180° with **Rotate LCD**.
4. If the sensor is to be operated exclusively using the bus system, both the  and  operating buttons can be locked here.



The two operating buttons  and  are unlocked within 10 seconds after the ambient condition sensor has been restarted and the **Settings menu** has been called up with .

5. Press **Back** → main menu.

## 15.4 Analogue output setting 4...20 mA



1. Select the **4...20 mA** field in the Settings menu with  and confirm with .

**Selection fields:** Channel 1 and fault current





2. Use  to select the desired selection field and confirm with .
3. Press **Back** → main menu.

### 15.4.1 Channel 1





**Parameter selection fields:** Status, unit, scaling 4 mA and scaling 20 mA

1. Use  to select the desired parameter and confirm with .
2. Make further settings.
3. Press **Back** → main menu.

### 15.4.2 State

1. Use  to select the desired field and confirm with :  
**on** activates the alarm output, **off** deactivates the alarm output.
2. Use  to select the desired unit and confirm with .
3. Press **Save** to accept the setting. Press **Cancel** to discard the change.
4. Press **Back** → settings menu 4 – 20 mA.

### 15.4.3 Unit



1. Use  to select the unit field and confirm with .
2. Use  to select the desired unit and confirm with .
3. Press **Save** to accept the setting. Press **Cancel** to discard the change.
4. Press **Back** → settings menu 4 – 20 mA.



## 16 Ethernet settings

1. Select the **Network** menu in the Settings menu with  and confirm with .

**Selection fields:** IP address, Modbus-TCP

2. Use  to select the desired selection field and confirm with .
3. Press **Back** → main menu.

### 16.1 IP address





Network address to a computer, **with** or **without DHCP**.



#### NOTE

With the DHCP protocol activated, automatic integration of the sensor into an existing network is possible without configuring it manually.

#### Set static IP, subnet and gateway



1. Use  to select the desired selection field (data field is highlighted in blue) and confirm with .
2. Use  to change the input value and confirm with .
3. Press **Button** > to move to the next data field or next position or to change the setting value, and confirm each with .
4. Press **Save** to accept the setting.

### 16.2 Modbus-TCP setup

The ambient condition sensor is equipped with a Modbus-TCP interface:

- HW interface M12 X-coded
- TCP port = 502, setting on the sensor
- Modbus unit address (unit identifier) 1...255
- Supported Modbus commands/functions:  
Function code 3: Read holding register  
Function code 16: Write multiple registers

### Set ID, port and byte format

1. Use  to select the desired selection field and confirm with .
2. Press **Button** > to move to the next data field or next position or to change the setting value, and confirm each with .
3. Press **Save** to accept the setting.



#### NOTE

Byte Format allows you to set the data format (word order).  
 Formats available for selection: ABCD (Little Endian) and CDAB (Middle Endian).  
 Reset to factory setting with **set default values**.

## 17 Info

Access the info menu with .

Press **Back** → main menu

Info	
Serial No.:	00000123
Cal. Date:	10.01.2013
Sensor Type:	IAC
Software Version:	1.30
Hardware Version:	1.01
Run Time:	0d 0h 00m 00s
VIn:	24.0 V
<b>Back</b>	



### 18 Status and error messages

#### 18.1 Error messages

**Low voltage**

appears if there is a supply voltage of  $< 11$  V. The ambient condition sensor will no longer measure properly. No measured values are available.

Troubleshooting: Check supply voltage. Ensure supply voltage  $\geq 11$  V.

**Internal Error**

Appears if an internal read error is registered (EEProm, AD converter, and so on).

Troubleshooting: Remove the ambient condition sensor and send it to CS Instruments GmbH & Co.KG.

**Temp out of range**

Appears if the temperature of the medium is outside the specified temperature range. This leads to faulty measured values outside the sensor specifications.

Troubleshooting: Check ambient temperature. If this is OK, remove the sensor unit and send it to CS Instruments GmbH & Co.KG.

**Low Voltage 4...20 mA**

Appears if the minimum supply voltage of 17.5 V is not reached.

Troubleshooting: Check supply voltage. Ensure supply voltage  $\geq 18$  V.

## 19 Maintenance



### NOTE

▶ The ambient condition sensor may only be removed by trained specialist personnel. Observe the safety instructions.

### 19.1 Replacing the sensor unit



### NOTE

▶ **Recommendation:** Keep a **spare sensor unit** on hand for calibration and maintenance work. This can be easily unscrewed from the sensor housing. After replacing with a new, calibrated sensor unit, reset the offset values if necessary → chapter 14.

### 19.2 Maintenance

The ambient condition sensor requires little maintenance. Check the sensor **annually** for damage and dirt.



### NOTE

Dirt particles in the ambient air cause measurement errors. A dirty sensor element can lead to a malfunction or failure. The ambient condition sensor may only be repaired by the manufacturer.

### 19.3 Calibration

Calibration: A (re)calibration is to be carried out depending on operational specifications and any intended DIN ISO certifications. Regular calibration is usually recommended after 2 years or at intervals determined by the operator.

### 19.4 Spare parts and repair



### NOTE

Keep an identical replacement sensor ready for use in systems that are essential for operation.

**Permitted installation or replacement by trained specialist personnel:**

Cover and display of the operating unit.

To ensure measurement accuracy and operational safety, all other repairs may only be performed by the manufacturer.

## 20 Disassembly

- Observe the safety instructions.

Disassembly is only permitted by trained specialist personnel.

## 21 APPENDIX

### 21.1 Modbus-RTU settings (2001...2005)

Modbus register	Register address	No. of bytes	Data type	Description	Default setting	Read write	Unit/comment
2001	2000	2	UInt16	Modbus ID	1	R/W	Modbus ID 1... 247
2002	2001	2	UInt16	Baud rate	4	R/W	0 = 1200 1 = 2400 2 = 4800 3 = 9600 4 = 19200 5 = 38400 6 = 115200
2003	2002	2	UInt16	Parity	1	R/W	0 = none 1 = even 2 = odd
2004	2003	2	UInt16	Number of stop bits		R/W	0 = 1 stop bit 1 = 2 stop bit
2005	2004	2	UInt16	Word order	0xABCD	R/W	0xABCD = Big Endian 0xCDAB = Middle Endian

### 21.2 Values Register IAC 500

Modbus Register	Register Address	No. of Byte	Data Type	Description	Read / Write	Unit
1001	1000	4	Float	Temperature	R	[°C]
1003	1002	4	Float	Temperature	R	[°F]
1005	1004	4	Float	Relative Humidity	R	[%]
1007	1006	4	Float	Pressure	R	[hPa, mBar]
1009	1008	4	Float	Pressure	R	[bar]
1011	1010	4	Float	Pressure	R	[psi]
1013	1012	4	Float	DewPoint	R	[°Ctd]
1015	1014	4	Float	DewPoint	R	[°Ftd]
1017	1016	4	Float	Absolute Humidity	R	[g/m <sup>3</sup> ]
1019	1018	4	Float	Absolute Humidity	R	[mg/m <sup>3</sup> ]
1021	1020	4	Float	Humidity Grade	R	[g/kg]
1023	1022	4	Float	Vapor Ratio (Volume)	R	[ppm]
1025	1024	4	Float	Saturation Vapor	R	[hPa]
1027	1026	4	Float	Partial Vapor Pressure	R	

## 21.3 Values Register Actual, Min &amp; Max IAC 500

Modbus Register	Register Address	No. of Bvte	Data Type	Description	Read / Write	Unit
1201	1200	4	Float	Temperature	R	[°C]
1203	1202	4	Float	Temperature Min	R	[°C]
1205	1204	4	Float	Temperature Max	R	[°C]
1207	1206	4	Float	Temperature	R	[°F]
1209	1208	4	Float	Temperature Min	R	[°F]
1211	1210	4	Float	Temperature Max	R	[°F]
1213	1212	4	Float	Relative Humidity	R	[%]
1215	1214	4	Float	Relative Humidity Min	R	[%]
1217	1216	4	Float	Relative Humidity Max	R	[%]
1219	1218	4	Float	Pressure	R	[hPa, mBar]
1221	1220	4	Float	Pressure Min	R	[hPa, mBar]
1223	1222	4	Float	Pressure Max	R	[hPa, mBar]
1225	1224	4	Float	Pressure	R	[bar]
1227	1226	4	Float	Pressure Min	R	[bar]
1229	1228	4	Float	Pressure Max	R	[bar]
1231	1230	4	Float	Pressure	R	[psi]
1233	1232	4	Float	Pressure Min	R	[psi]
1235	1234	4	Float	Pressure Max	R	[psi]
1237	1236	4	Float	DewPoint	R	[°Ctd]
1239	1238	4	Float	DewPoint Min	R	[°Ctd]
1241	1240	4	Float	DewPoint Max	R	[°Ctd]
1243	1242	4	Float	DewPoint	R	[°Ftd]
1245	1244	4	Float	DewPoint Min	R	[°Ftd]
1247	1246	4	Float	DewPoint Max	R	[°Ftd]
1249	1248	4	Float	Absolute Humidity	R	[g/m <sup>3</sup> ]
1251	1250	4	Float	Absolute Humidity Min	R	[g/m <sup>3</sup> ]
1253	1252	4	Float	Absolute Humidity Max	R	[g/m <sup>3</sup> ]
1255	1254	4	Float	Absolute Humidity	R	[mg/m <sup>3</sup> ]
1257	1256	4	Float	Absolute Humidity Min	R	[mg/m <sup>3</sup> ]
1259	1258	4	Float	Absolute Humidity Max	R	[mg/m <sup>3</sup> ]
1261	1260	4	Float	Humidity Grade	R	[g/kg]
1263	1262	4	Float	Humidity Grade Min	R	[g/kg]
1265	1264	4	Float	Humidity Grade Max	R	[g/kg]
1267	1266	4	Float	Vapor Ratio (Volume)	R	[ppm]
1269	1268	4	Float	Vapor Ratio (Volume) Min	R	[ppm]
1271	1270	4	Float	Vapor Ratio (Volume)	R	[ppm]

## 21.4 Index Units

Index	Unit	Index	Unit	Index	Unit	Index	Unit	Index	Unit
1	°C	21	Nltr/min	41	V	61	kVAr	65	W
2	°F	22	Nltr/s	42	μV	62	-	81	g/s
3	%RH	23	SCFM	43	kV	63	€	82	g/min
4	°Ctd	24	m <sup>3</sup>	44	mA	64	cts/m <sup>3</sup>	83	m
5	°Ftd	25	ltr	45	A	65	W	84	ft
6	mg/kg	26	cf	46	kg/s	66	Wh	85	min.
7	mg/m <sup>3</sup>	27	Nm <sup>3</sup>	47	kg	67	h	86	ms
8	g/kg	28	Nltr	48	AVm <sup>3</sup> /h	68	dB		
9	g/m <sup>3</sup>	29	SCF	49	AVl/h	69	mm		
10	m/s	30	ppm	50	AVkg/h	70	inch		
11	fpm	31	°CtdR	51	AVcf/h	71	ltr/h		
12	Nm/s	32	°FtdR	52	kg/h	72	Nltr/h		
13	SFPM	33	Pa	53	kg/min	73	lb/h		
14	m <sup>3</sup> /h	34	hPa	54	Ohm	74	lb/min		
15	m <sup>3</sup> /min	35	kPa	55	Hz	75	lb/s		
16	ltr/min	36	MPa	56	%	76	t/h		
17	ltr/min	37	mbar	57	kW	77	t		
18	ltr/s	38	bar	58	kWh	78	lb		
19	cfm	39	psi	59	PCS	79	SCFH		
20	Nm <sup>3</sup> /h	40	mV	60	kVA	80	cfh		

## Declaration of conformity



# KONFORMITÄTSERKLÄRUNG

## DECLARATION OF CONFORMITY

Wir CS Instruments GmbH & Co.KG  
We Gewerbehof 14, 24955 Harrislee

Erklären in alleiniger Verantwortung, dass das Produkt  
Declare under our sole responsibility that the product

**Sensor für Umgebungsbedingungen IAC 500**  
Sensor for Ambient-Conditions IAC 500

den Anforderungen folgender Richtlinien entsprechen:

We hereby declare that above mentioned components comply with requirements of the following EU directives:

Elektromagnetische Verträglichkeit Electromagnetic compatibility	2014/30/EU 2014/30/EC
RoHS (Restriction of certain Hazardous Substances)	2011/65/EC & 2015/863/EC

Angewandte harmonisierte Normen:

Harmonised standards applied:

EMV-Anforderungen EMC requirements	<b>EN 55011:2016 + A1:2017</b> <b>EN 61326-1: 2013</b>
---------------------------------------	---

Das Produkt ist mit dem abgebildeten Zeichen gekennzeichnet.  
The product is labelled with the indicated mark.



Villingen-Schwenningen, den 16.01.2023

  
Wolfgang Blessing Geschäftsführer